

## HY series HY01601

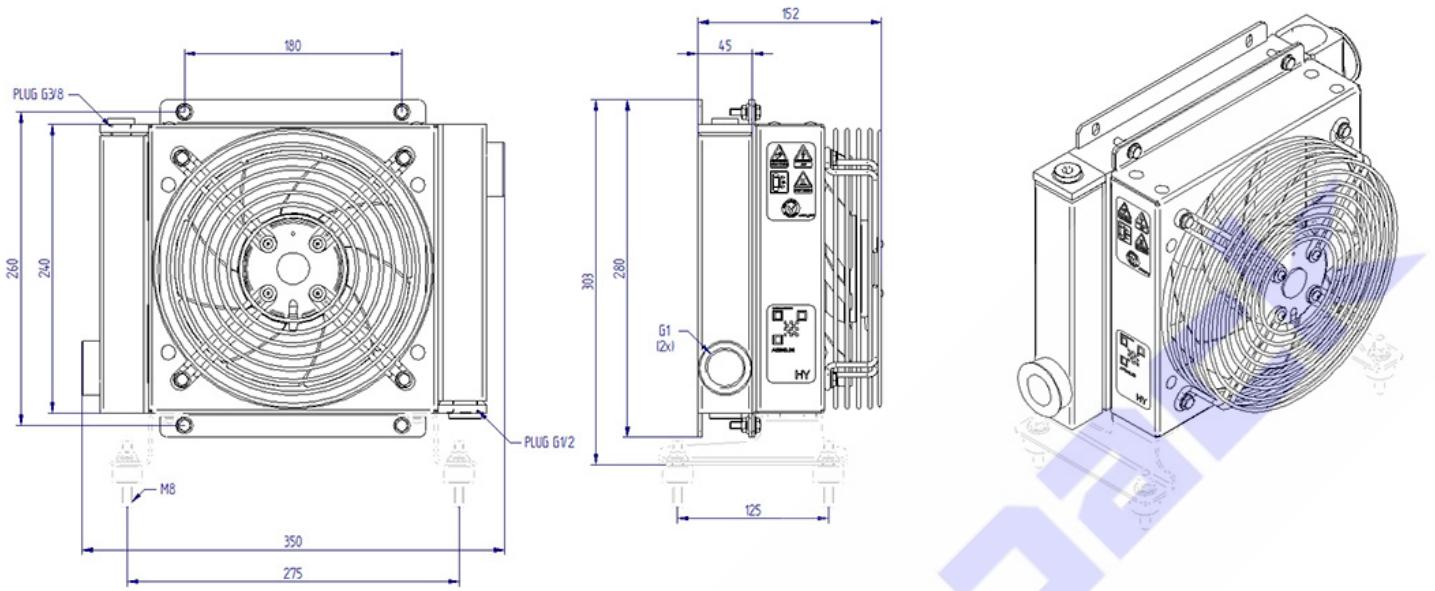

### Technical data

Item	Oil flow [l/min]	Capacity [l]	Weight [kg]	Rpm	Voltage [V]	Frequency [Hz]	Current absorption [A]	Power [W]	Ø Fan [mm]	Air flow [m³/h]	Noise level [db(A)]
<b>HY01601</b>	10-90	0,7	7		230	50/60	0,34	64	200	735	65
<b>HY01603</b>	10-90	0,7	7		230/400	50/60	0,17	68	200	745	65

### Performance

### Pressure drop

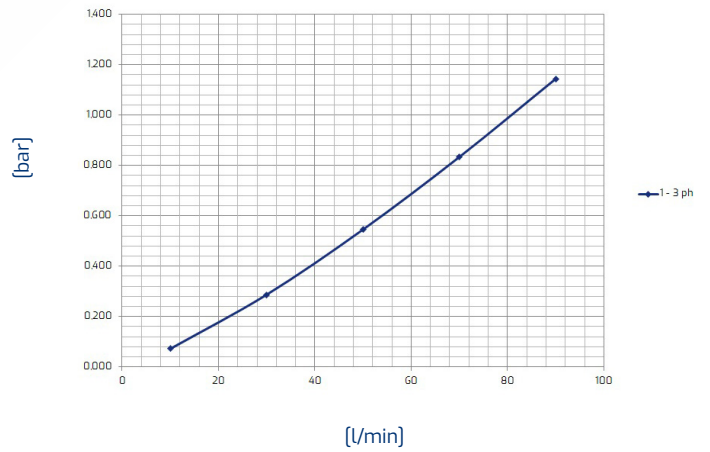
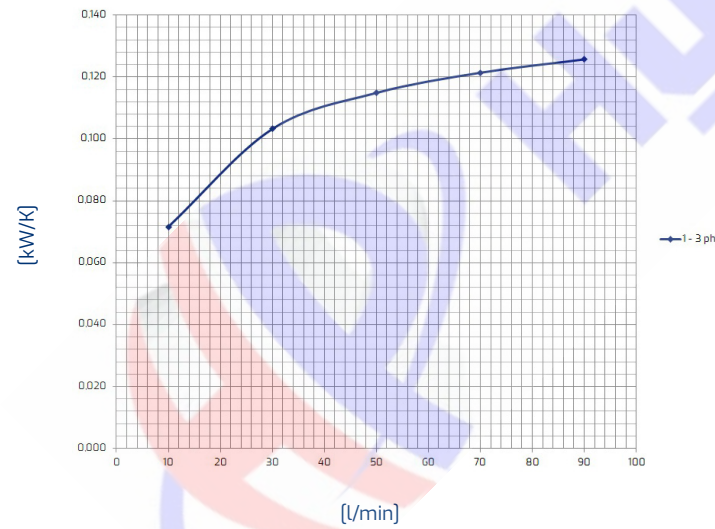

Oil T 80°C  
T Amb. 40°C

Viscosity - ISO VG 32 Oil					
Oil	22	32	46	68	150
Correction factor	0,8	1	1,2	1,6	3